

Electric Resistance Pedestal Paver Snow Melt DATA SHEET

Description:

The Heatizon Pedestal Paver Snow Melt system provides an effective heatsink to boost heat transfer for MI Cables (Mineral Insulated) or other electric resistance heaters installed in pedestal paver systems on roofs, decks, bridges, ramps, platforms, or anywhere a pedestal paver system is installed. The Heatizon Pedestal Paver Snow Melt system is simple in design and allows easy integration and installation for many applications.

Design:

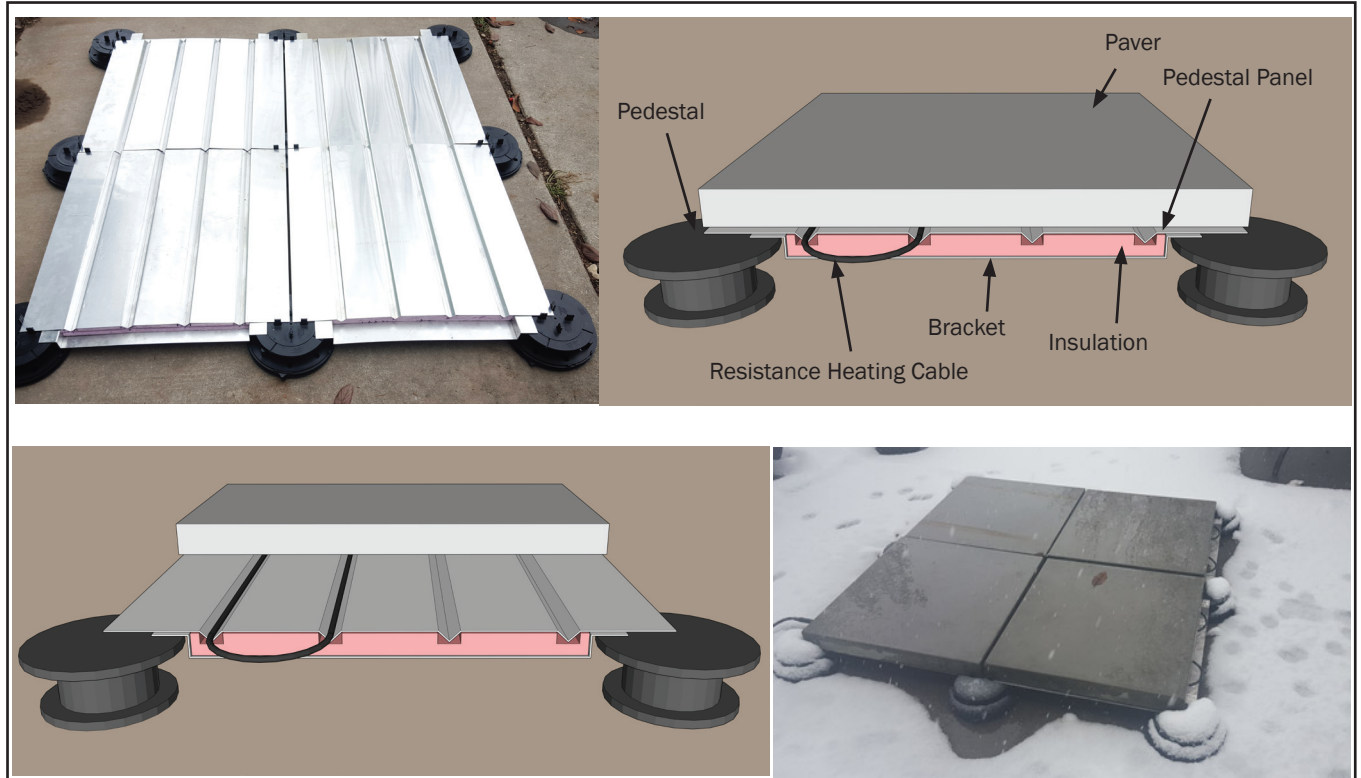

Specifications:

Length	23.5"
Width	Varies but no less than 23.5"
Profile Height	1" with insulation
Material	Aluminum/EPS Insulation
Attachment Method	Free placement

Applications:

Roof Top Pavers	Drainage Systems
Pedestal Systems	
Green Roofs	
Hardscapes	

Features & Benefits:

Easy Installation	Versatile Applications
Customized Lengths	Easy Control Integration
Effective Heat Transfer	Customized Material
Protects Heating Cable	



Note: Ground fault protection (30 mA trip protection) must be used when installing line voltage snow melting products. Refer to the NEC or CEC for specific requirements.



COMFORT RADIANT HEATING, LLC
 (888)448-0555 (518)373-5700

www.comfortradiant.com

M330G-40a Relay Panel

DATA SHEET

Description:

Enclosed in an attractive powder coated metal enclosure, the M330 series Heatizon Relay Panels are designed to operate up to four line voltage heating element lengths manually, from one Heatizon Activation Device, or from a Heatizon Systems Monitor Station Selector Box (Heatizon Part No. M346).

- Powder coated enclosure with wiring diagram on the inside cover. (Other enclosures are available upon request)
- Lighted rocker switches for manual operation.
- Easy connection of power supply and load for up to four circuits.

Design:



Applications:

- Snow Melting
- Roof Deicing
- Floor Warming
- Space Heating
- Pipe Tracing
- Gutter and Downspout Tracing

Benefits:

- Allows one activation device to turn up to four lengths of cable on and off either remotely or manually.
- Can be turned on remotely or manually

Features:

- Power On/Off switch for each circuit
- Up to four 40 Amp loads.
- Relays provide easy connection to load and power source.
- Compatible with most Heatizon supplied activation devices and Heatizon Systems'
- Selector Box (Heatizon Part No. M329 Modified).

Specifications:

- Requires 120V, Switches 120/208/240/277/480 VAC
- Dimensions: 18" x 12" x 5"
- Weight: 15 lbs

Wiring:

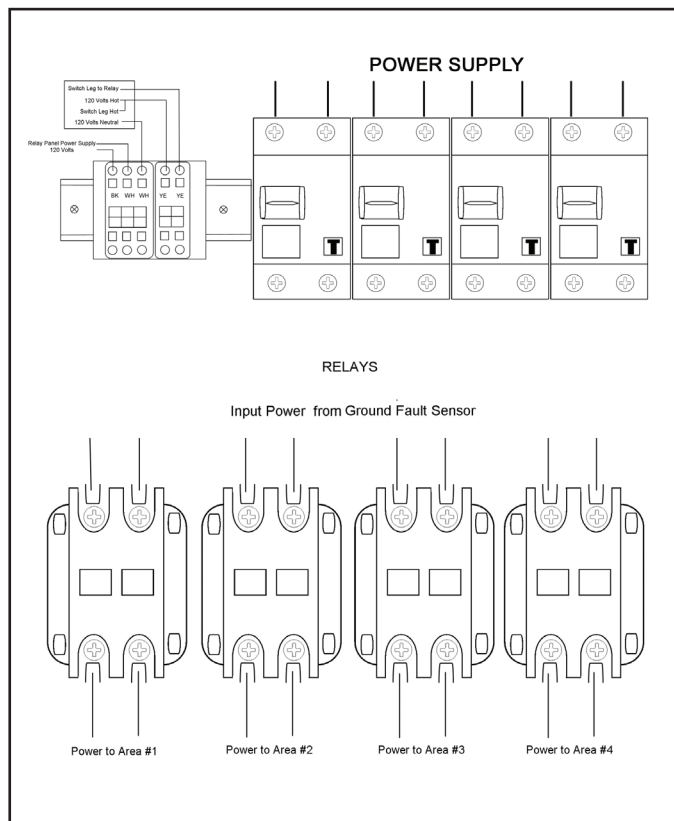

Note: Refer to the NEC or CEC for specific requirements.



COMFORT RADIANT HEATING LLC
 9 Morris Lane, Clifton Park, NY 12065
 (888)448-0555 (518)373-5700
 www.comfortradiant.com

M326ARSC Ice & Snow Sensor Controller

DATA SHEET

Features:

- Activates System when moisture is detected and temperature is below set point
- 34° - 44° F : Field Selectable
- Automatic Activation means Lower De-icing Costs
- Reliable Rain and Snow Detection
- Replaceable Precipitation Sensor
- Easy Installation, Full Access to Electronics
- Adjustable Temperature Trigger
- Adjustable Delay Off Cycle, Selectable 30-90 Minutes or 2-6 Hours
- Adjustable Sensitivity Control
- Selectable Low Temperature Cutoff
- Smart "Manual On" Operates for One Delay Off Cycle
- Bright Power/Activation LED Indicator

Applications:

- For Use with SLC500, CBX Series, Radiant 8, M329, M346, M330 Series, M530 Series
- Direct Load Switching up to 30A/277VAC
- Snow Melting
- Roof Deicing
- Gutter Deicing/Melting

Design:



Specifications:

- Requires 100-277 VAC
- Full 30A @ 277 VAC Control
- Dimensions: 4³/₄"(120) x 7"(178) x 2³/₄"(70)
- Weight: 2 pounds
- Front cover electronics access

Wiring:

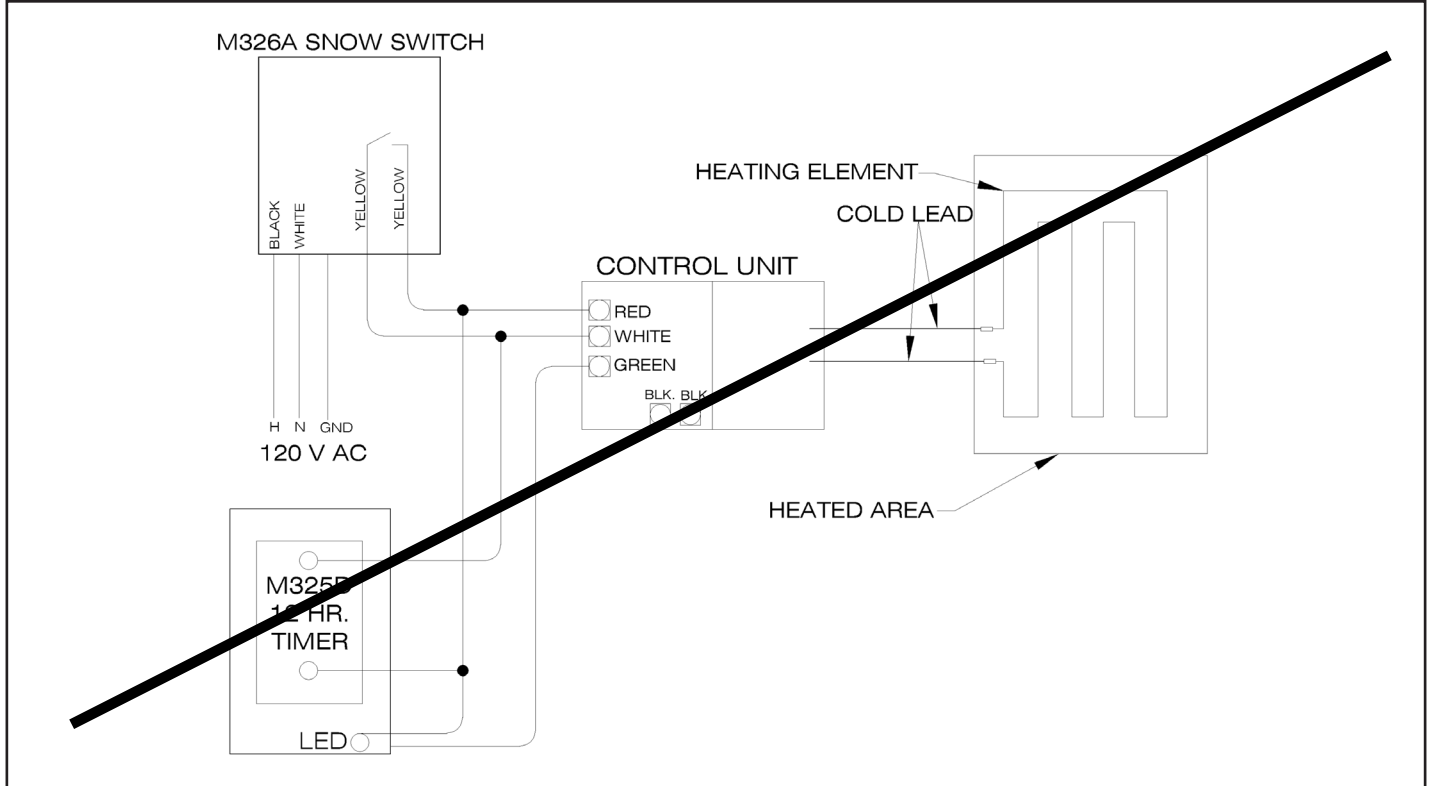

Note: Refer to the NEC or CEC for specific requirements.



COMFORT RADIANT HEATING LLC

9 Morris Lane, Clifton Park, NY 12065

(888)448-0555 (518)373-5700

www.comfortradiant.com

M326A Ice & Snow Sensor Controller

DATA SHEET

Wiring:

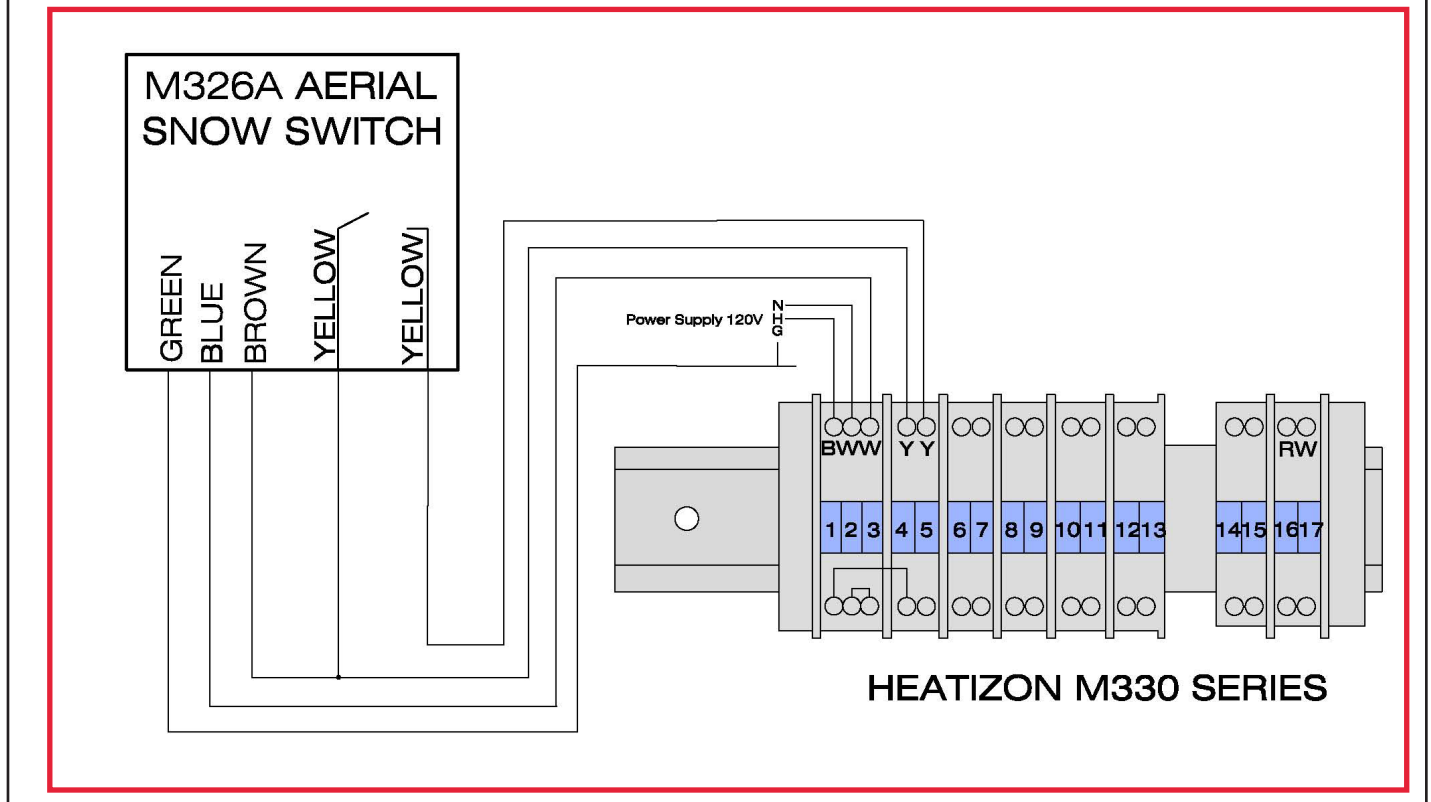
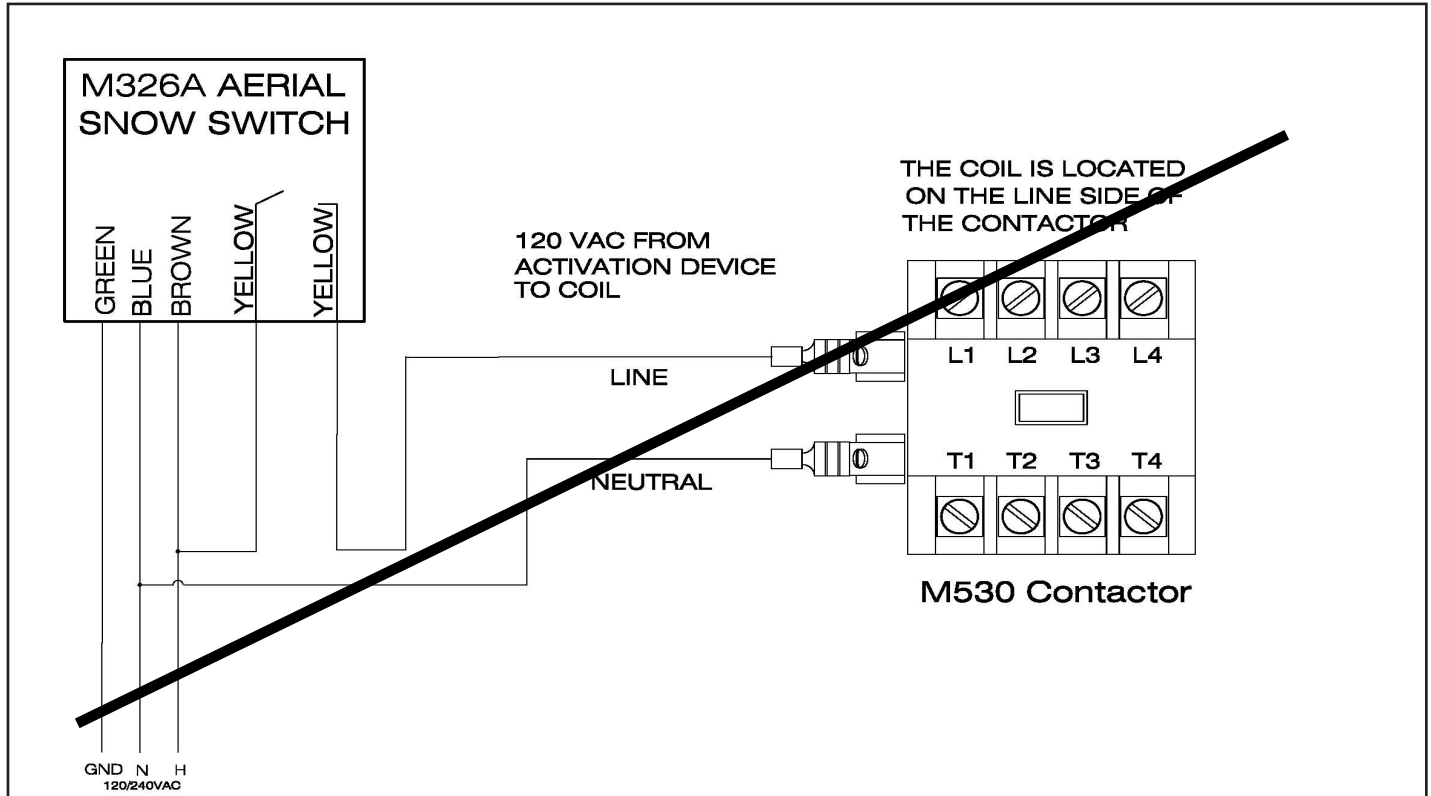

Note: Refer to the NEC or CEC for specific requirements.



COMFORT RADIANT HEATING LLC
 9 Morris Lane, Clifton Park, NY 12065
 (888)448-0555 (518)373-5700
 www.comfortradiant.com

Hott-Wire® (MI) Snow Melting & De-icing Cable

DATA SHEET

Hott-Wire® is a high quality Mineral Insulated (MI) heating cable designed as a single or dual conductor heating element woven in a fiberglass matrix compressed by a seamless copper sheath. Hott-Wire® is designed to provide an effective means of melting snow and ice with 100% efficiency. Our system is capable of delivering a wide range of heating outputs and can be custom designed for specific

projects and applications. Hott-Wire® is one of the most rugged heating cable designs available that is also specifically designed for resistance heating. Hott-Wire® can be installed in a variety of surfaces such as new pour concrete, existing concrete as a retrofit, a sand bed below pavers, stone dust, and even new pour asphalt applications. Hott-Wire® can be powered by any voltage up to 600

volts. Our cutting edge manufacturing process makes Hott-Wire® superior in strength, reliability, convenience and stability as a heating cable. With pre-attached cold leads, Hott-Wire® is designed to be easy to install in areas large and small, for a variety of applications accomodating residential, commercial, or inudustrial projects.

Design:

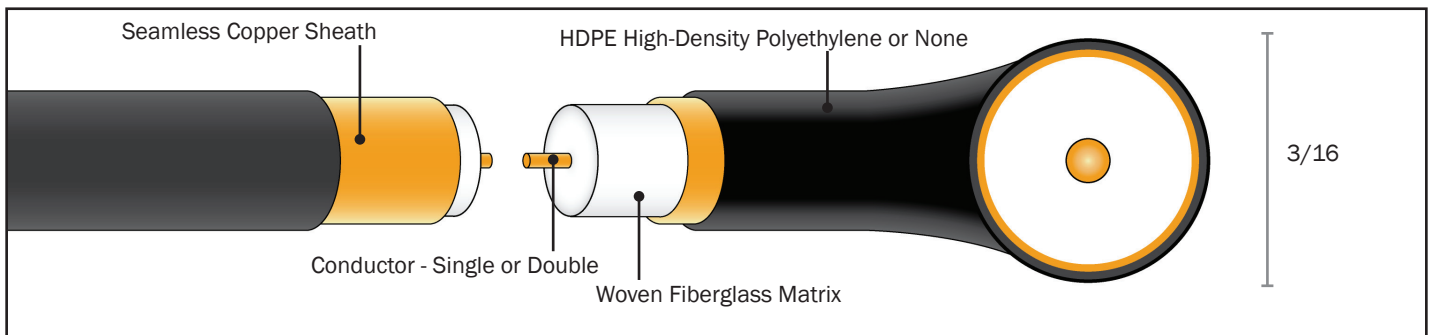

Conductor	Nickel Coated Copper	0.02 to 2.0 Ω/ft
Conductor Insulator	Woven Fiberglass Matrix	
Grounding Sheath	Seamless Copper	
Outer Jacket	(HDPE) High-Density Polyethylene or None	
Minimum Bending Radius	5D (Approx. 1")	
Minimum Spacing	2"	
Supply Voltage	Up to 600VAC	
HDPE Maximum Temperature	248°F (120°C)	with HDPE Jacket
Thermal Resistance Temperature	482°F (250°C)	
Output Wattage	Up to 40 watts/ft single conductor or 25 watts/ft double conductor	
Warranty	10 Year Limited Warranty	
Listing Agency	ETL (Intertek Testing Laboratory)	

Sample Labeling Information:

Sample Label: S / 0.02 / 240V / 308ft / 7,849W
 Key: (S = Single Conductor, D = Double Conductor) / (0.02 = Ohm/ft) / (240V = Voltage) / (308ft = MI Cable Length) / (7,849W = Total Wattage)

Applications:

Walkways	Entry Areas
Driveways	Helicopter Pads
Bridges	Stairs
Handicap Ramps (ADA)	Patios

Surfaces:

Concrete (New Pour)	Concrete (Retrofit Existing)
Asphalt (New Pour)	Asphalt (Retrofit Existing)
Sand Under Pavers	
Stone	



Note: Ground fault protection (30 mA trip protection) must be used when installing Hott-Wire products. Refer to the NEC or CEC for specific requirements.



COMFORT RADIANT HEATING LLC
 9 Morris Lane, Clifton Park, NY 12065
 (888)448-0555 (518)373-5700
www.comfortradiant.com

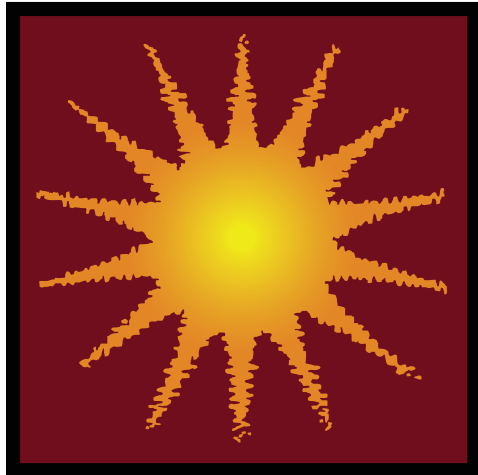

HEATIZON
S Y S T E M S

RADIANT HEATING SYSTEMS

- **SNOW MELTING**
- FLOOR WARMING
- SPACE HEATING
- ROOF DEICING
- GUTTER DEICING

A graphic consisting of three curved, overlapping lines in yellow and orange, arching over the text.

Hott-Wire®

Hott-Wire® Mineral Insulated (MI) Cable Design & Installation Manual

Hott-Wire® is a registered trademark of Heatizon Systems.



**Read this entire Design and
Installation Manual prior to
installing Hott-Wire® Cable.**



HOTT-WIRE® SYSTEM INSTALLATION & OPERATING MANUAL

TABLE OF CONTENTS

Concrete Suggestons	5
Concrete Joints with Jumpers	6
Notes, Warnings, & Specifications	7
Basic System & Cable Design	9
INSTALLATION & MAINTENANCE	10
STEP 1- LAYOUT	10
STEP 2- JUMPERS	11
STEP 3- OBJECTIVES	11
STEP 4- CONFIRM MATERIALS	12
STEP 5- RECORD RESISTANCE (1)	12
STEP 6- PREPARE AREA	13
STEP 7- TRANSFER THE PLAN	14
STEP 8- INSTALL HOTT-WIRE®	16
STEP 9- ACTIVATOR	19
STEP 10- RECORD RESISTANCE (2)	20
STEP 11- ASPHALT, CONCRETE, PAVERS	20
STEP 12- RECORD RESISTANCE (3)	21
STEP 13- POWER CONNECTION	22
STEP 14- TROUBLESHOOTING	22
STEP 15- ATTACH LABELS	22
Warranty Information	25
Resistance/Warranty Return Form	LAST PAGE

Distributed by:

Heatizon Systems
4137 South 500 West
Murray, UT 84123
Phone: (801) 293-1232
Fax: (801) 293-3077
info@heatizon.com
heatizon.com



A FEW CONCRETE SUGGESTIONS

Heatizon Systems is not an asphalt, concrete or pavers expert, but we have a few suggestions that you may wish to discuss with your contractor. We make these suggestions in an effort to increase the likelihood that Heatizon Systems' Hott-Wire® MI Cable will be surrounded by products that are equal to it in both quality and expected longevity. In addition, we make these suggestions in an effort to reduce the possibility that your Hott-Wire® heating element will get damaged or broken by the vertical or horizontal movement of asphalt, concrete, or pavers.

Dry Base: Make certain that the ground below where the new asphalt, concrete or pavers will be located is as dry as possible. It is recommended that it be covered whenever there is a risk of a storm for one to two weeks prior to the pour.

Excavation: Be sure that your excavation is deep enough to accommodate the thickness of the concrete, the thickness of the insulation, the depth of the aggregate base you will have below the concrete and a 1" sand bed if you elect to install the Hott-Wire® MI Cable below the concrete.

Compaction: Once the excavation is complete, it is highly recommended that a great deal of care be given to completely and properly compact the entire area where the asphalt, concrete or pavers will be located.

Drainage: In order to have proper drainage and to reduce the likelihood of vertical shifting of your asphalt, concrete, or pavers Heatizon Systems recommends that a minimum of 6 inches of high quality aggregate be laid over the entire area where the asphalt, concrete, or pavers are to be installed, plus one foot around all edges.

Reinforcement: In order to enhance the integrity of your asphalt, concrete or pavers, Heatizon Systems recommends that reinforcement be considered. Most of the time concrete can be reinforced with number 4 gauge welded wire fabric or ½ inch re-bar placed at least 2 inches from the top and bottom surfaces of the concrete.

Insulation is a two edged sword. On the one hand, it acts as a good moisture barrier, reduces the response time of your snow melt or heating system, and saves money by reducing operating time. On the other hand, insulation does not allow the heat from the ground to get into the asphalt, concrete, or pavers.

Maximum Area: Heatizon Systems recommends that concrete be poured in square sections no larger than 9.5 feet X 9.5 feet. Pouring other geometric shapes without additional joints almost always results in cracking. Each square must always have a joint on each of its four sides.

Thickness: Heatizon Systems always recommends the following thickness be observed:

Concrete	5 or more inches
Asphalt	4 or more inches
Pavers	4 or less inches

Suggested Mix: Heatizon Systems recommends that a six-bag mix with fiber or steel fibers always be used when pouring concrete.

CONCRETE JOINTS AND USING JUMPERS

Control Joints: Control Joints are intended to control where the slab will crack and are placed either in fresh concrete or saw cut in after the concrete is poured. Spacing of these joints will vary depending on the size and shape of the slab. Use a Hott-Wire® MI Cable Jumper to protect the heating cable when crossing control joints (Refer to Step 2 "PLAN THE JUMPERS").

Construction Joints: Construction joints are a common result when multiple concrete pours are completed at different stages during construction. Use a Hott-Wire® MI Cable Jumper to protect the heating cable when crossing construction joints (Refer to Step 2 "PLAN THE JUMPERS").

Expansion Joints: Expansion or Isolation joints result when concrete is isolated from something else which can be concrete, a wall, column etc. When an expansion joint is used between two concrete slabs the two structures are not connected using rebar, therefore movement can/will occur between them. Do not cross expansion joints with the heating portion of the cable. The cold lead portion of the cable may cross under expansion joints as long as the cold lead is buried under or sleeved with conduit below.

Jumpers: It does not matter what kind of joint is in the asphalt or concrete, heating cables should never be allowed to run through them unprotected. Always use a Heatizon Systems jumper under or through any and all joints. The Heatizon Hott-Wire® Cable Jumper Kit (Heatizon Part #MICABJMPKIT) includes 4 jumpers.

SAMPLE APPLICATION: HOTT-WIRE® IN A CONCRETE SLAB

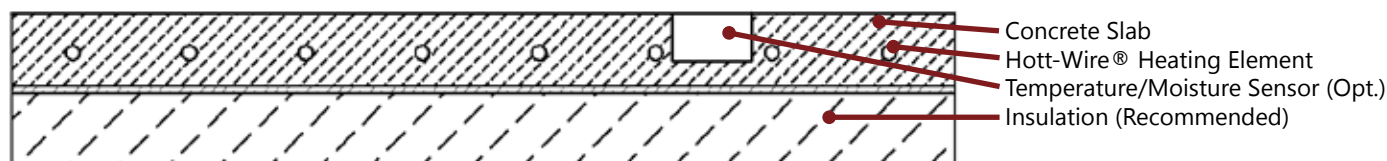

SAMPLE APPLICATION: HOTT-WIRE® IN A SAND BED UNDER CONCRETE, ASPHALT OR PAVERS

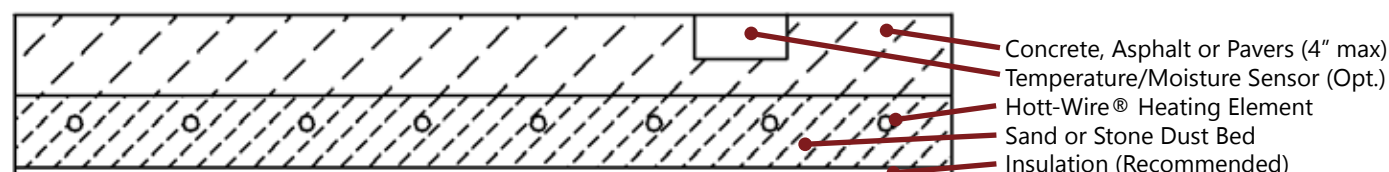

SAMPLE APPLICATION: HOTT-WIRE® RETROFIT IN CONCRETE OR ASPHALT

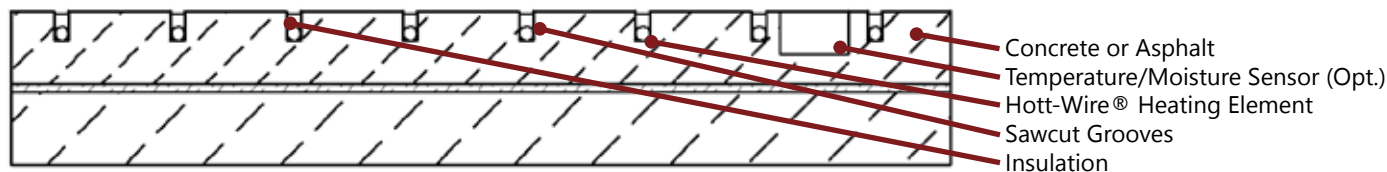

SAMPLE APPLICATION: HOTT-WIRE® IN PEDESTAL PAVER PANS

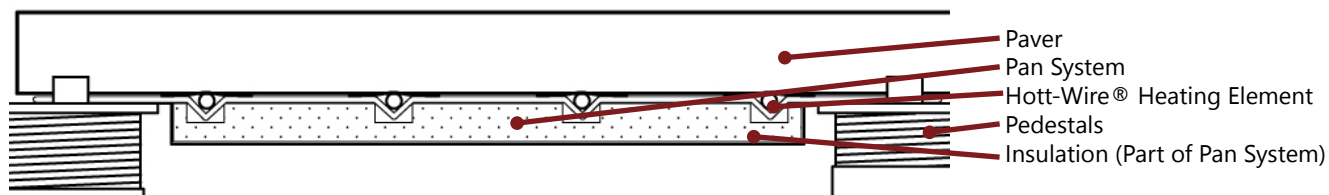



WARNINGS

- Do not overlay, twist, kink, or spiral the Hott-Wire® Cable.
- Always test Hott-Wire® with a megohmmeter prior to installing, once installation is complete, and prior to energizing. In the event Hott-Wire® MI Cable fails any megohmmeter test, call Heatizon at 801-293-1232.
- The minimum installation temperature is 40°F (5°C).
- Do not cut the Hott-Wire® heating element, or alter or modify it in any way.
- Use only copper wire from the distribution panel to the Hott-Wire® cold leads.
- Do not allow the Hott-Wire® Heating Element to touch or cross itself, its cold leads, any gas lines or electrical conductors.
- Hott-Wire® Cable copper or braided sheath must be grounded to a suitable earth ground.

NOTES:

Always measure, verify and record the actual resistance at specific points throughout the installation process. A resistance recording page is included in this manual for this purpose. Compare each reading to the ratings on the product table for MI Cable and to the original reading for MI Cables. If the taken readings differ from those expected on the product table, do not energize the Hott-Wire® Cable, and call Heatizon Systems at 801-293-1232.

Always roll the Hott-Wire® spool or uncoil the coil to unreel the heating element. Do not pull Hott-Wire® Cable from the spool.

Remember to verify that the supply voltage matches the design voltage of the Hott-Wire® Cable product you have purchased.

Remember to use asphalt, concrete, a sand bed, thin-set, or a cement based self-leveling product to embed the Hott-Wire® Heating Element.

Metal structures or materials used to install or support the Hott-Wire® Heating Element must be grounded in accordance with CSA Standard C22.1, Section 10, and with the NEC.

Please contact Heatizon Systems at 801-293-1232 with additional questions.

Required Tools:



500VDC Megohmmeter

Digital Multimeter (DMM)

Screwdrivers, Utility Knife, Wire Strippers.



Wattage Recommendations

Do not exceed these maximum wattages:

Application	Watts per linear foot
Concrete	28
Asphalt	25
Sand, Stone Dust under Pavers	24

120V and 277V Connection		208V, 240V and 480V Connection	
Phase	Cold Lead	Phase	Cold Lead
Neutral	Cold Lead	Phase	Cold Lead
Ground	Copper Shield	Ground	Copper Shield

Hott-Wire® Cable Specifications

Heating cable	Hott-Wire®
Voltage	120, 208, 240, 277, 480, or 600V
Watts	Up to 40W per lin. ft.
Length	Refer to product label
Diameter/Height	5mm (Approx. 3/16")
Bending Radius	5D** (Approx. 1")
Cable Type	Mineral Insulated 1 or 2 Conductor
Insulation	Fiberglass
Outer Jacket	HDPE 120°C (248°F)
Temperature Max	250°C (482°F)
Minimum Spacing	2"
Standard Spacing	4" to 9"
Cap Thickness	2" min to 4" max
Thermal Resistance	482°F (250°C)

**5 Times (5D) the Hott-Wire® diameter.

Sample Labeling Information

Sample 1: S-0.02-240V-308F-7849

S: Hott-Wire® Cable
 S = Single Conductor
 D = Double Conductor
 0.02: Hott-Wire® Cable Resistance/ft
 240V: Hott-Wire® Cable Design Voltage
 308F: Hott-Wire® Cable Length (ft)
 7849: Hott-Wire® Cable Set Total Wattage

NOTES:

- It is important that Hott-Wire® cable be installed only by qualified persons who are familiar with the proper sizing, installation, construction and operation of snow melting systems and the hazards involved. Hott-Wire® products are designed for in and under concrete, asphalt, and paver snow melt applications.
- Hott-Wire® must be installed in accordance with the manufacturer's installation instructions, as well as with the National Electric Code (NEC) and Canadian Electrical Code (CEC), part 1, and local codes and regulations.
- Section 426-28 of the NEC requires ground fault protection for mineral insulated equipment embedded in a noncombustible medium. Check local building codes and regulations for ground fault protection device (i.e. GFCI, GFEP, etc.) requirements when installing all Hott-Wire® MI products.
- Do not bend Hott-Wire® within 3" of a termination or connection between the Hott-Wire® Heating Element and the cold lead.
- Store Hott-Wire® Heating Cable in a cool, dry place.
- Section 426.20 of the NEC limits embedded deicing and snow melting equipment to a maximum of 1300 watts/m² (120 watts/ft²) of heated area.



HOTT-WIRE® BASIC SYSTEM DESIGN:

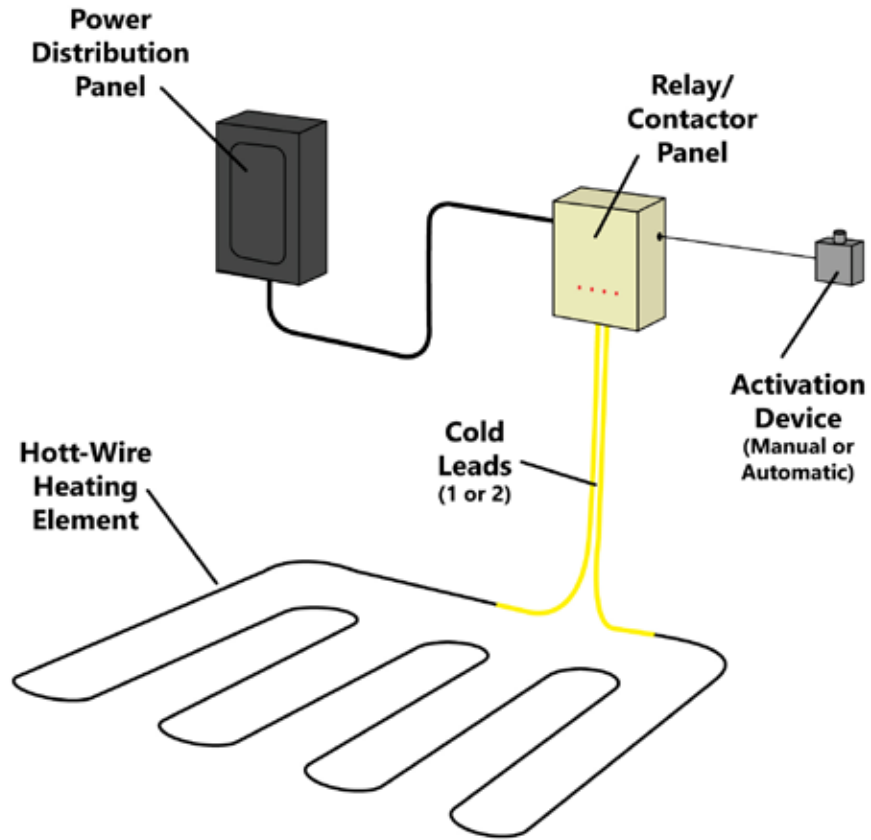

HOTT-WIRE® CABLE DESIGN:

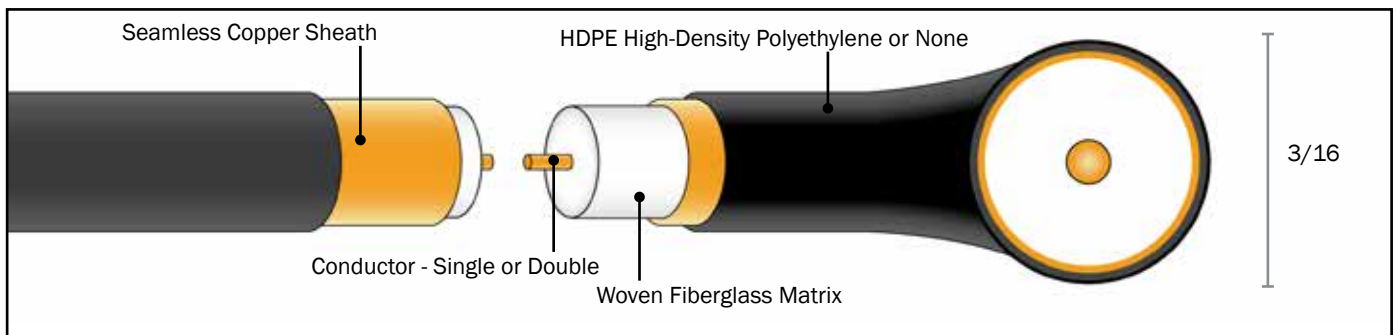

STEP 1

PLAN THE LAYOUT

DESIGN AND INSTALLATION

Gather Necessary Information:

- Size and layout of area
- Voltage and Amperage Available
- Geographic Location
- Cover or cap material and thickness (2" minimum)

Design Requirements

- Whenever possible, The American Society of Heating, Refrigeration and Air Conditioning Engineers (ASHRAE) design criterion should be followed.
- Hott-Wire® should not be closer than 6" to the edge of the slab
- Only jacketed Hott-Wire® cables are acceptable for installation into asphalt, concrete, or a sand or stone dust bed.
- All Hott-Wire® snowmelt systems may be activated manually or automatically.
- Identify and mark for jumpering the location of all future joints in asphalt or concrete.

Draw a sketch of the area where Hott-Wire® snow melt will be installed. The sketch should show all measurements and dimensions in order to determine the area to be snow melted. Determine location for the Hott-Wire® activation device.

NOTES:

- Make certain to plan for the movement of water created by melted snow.
- Activation Devices are the eyes and ears of the heating system. Location is important. Please reference installation and operation information in the activation device product literature. Some activation devices may or may not require a different voltage than the heating cable.
- Heatizon constant wattage cables are designed for specific voltages and watt densities. These heating cables can be designed for any voltage up to 600VAC but typical design voltages are 120, 208, 240, 277, 480, and 600VAC. Be sure to check product label for correct input power and watt density design for your installation.
- The transition joint between the heating element and the cold lead must be embedded in asphalt, concrete, sand, stone dust, cementitious material or transition into the paver pan in the groove. Do not bend the heating cable within 3" of cold connection.

ELECTRICAL POWER DISTRIBUTION

Breaker Size (Amps)	Max Load (Amps)
50	40
40	32
30	24
20	16
15	12

ACTIVATION DEVICE OPTIONS

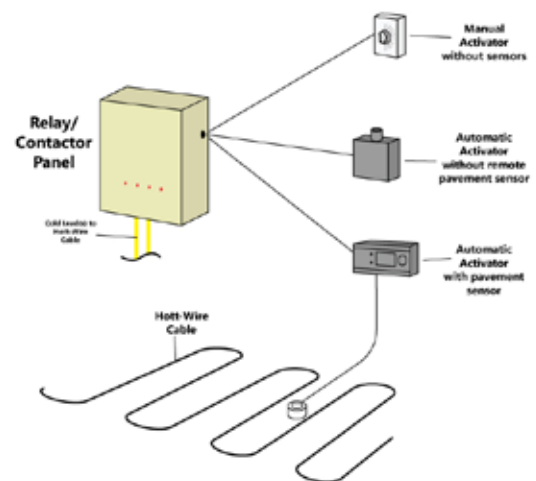



PLAN THE JUMPERS

STEP 2

ASHRAE and Heatizon always require the use of jumpers through joints. Never extend the heating cable through any joint in asphalt and/or concrete without a jumper. Determine the number of joints in order to determine the number of Jumper Kits required for the project. Always jumper under or through all joints using the appropriate jumper kit provided by Heatizon Systems. Refer to earlier section, A FEW CONCRETE SUGGESTIONS of this manual for information about types of joints in concrete and asphalt to consider.

HOTT-WIRE® (MI) CABLE JUMPER

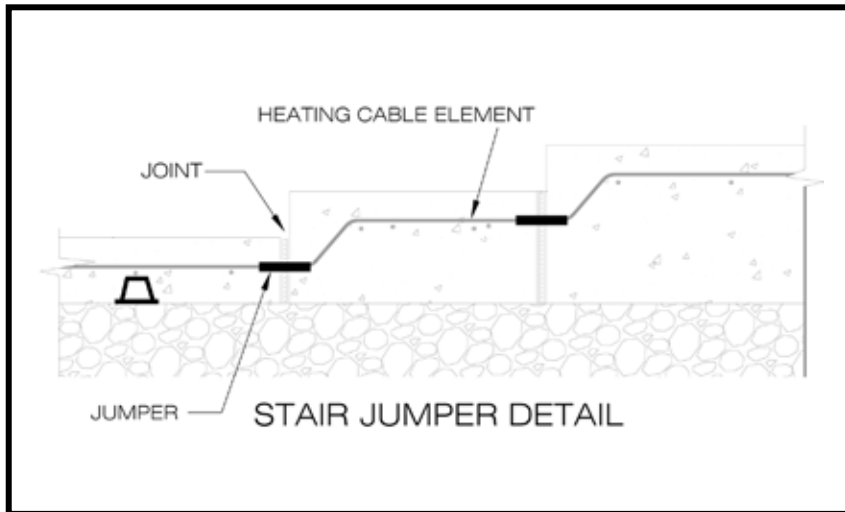
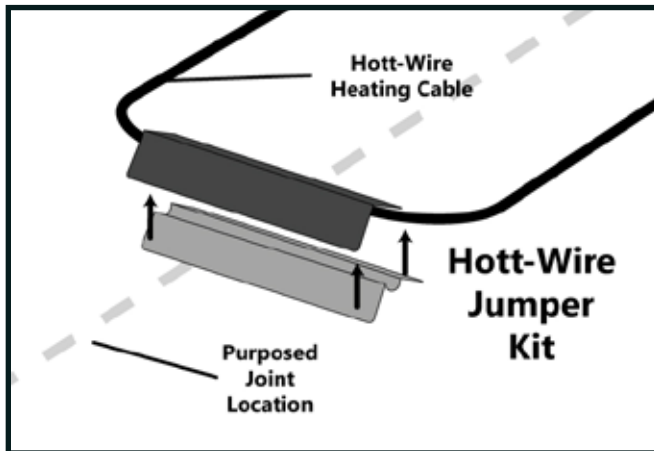

JUMPER PLACEMENT

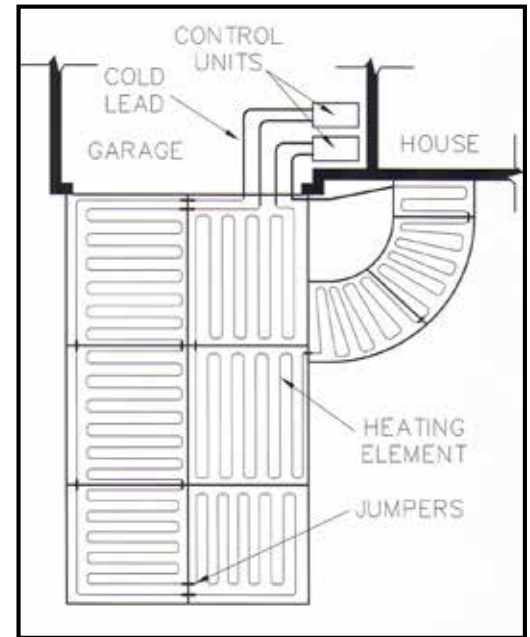

Sample Driveway and sidewalk layout for two Hott-Wire® MI Cable snow melting sets. Note that jumpers extend the Hott-Wire® heating element through all joints and marks.

STEP 3

VERIFY SNOW MELTING OBJECTIVES

SNOW MELT DESIGN PERFORMANCE

Contact your Heatizon Distributor or Representative for assistance in determining the Watts per square foot needed to accomplish your snow melting objectives. Heatizon recommends that, whenever possible, all snow melting projects be designed using ASHRAE's design criterion. In the event access to ASHRAE's design criteria is not available or applicable, then the "General Guidelines for Product Selection" table on the next page may be helpful.

(CONTINUED)

SYSTEM COMPONENTS

There are 4 main components for a snow melting system, but these can be customized and changed depending on project requirements and some activators will switch loads for smaller systems.

Components of a Snow Melting System:

- Heating Cable(s)
- Activation Device(s)
- Jumpers
- Load Switching Device(s)
(Relay Panel, Contactor Panel, or Custom Heatizon UL 508A Industrial Control Panel)

If the design is complete the space between lengths of Hott-Wire® Heating Element and the total length of each Hott-Wire® zone has already been determined and will satisfy the projects snow melting objectives, proceed to order and receive materials.

GENERAL GUIDELINES FOR PRODUCT SELECTION



For heavy snow areas or critical emergency accesses, ADA critical areas, landing pads.*	30+ Watts per square foot (323 Watts/M2)
Areas with higher than average amounts of snow or having medium pedestrian traffic or commercial accesses, residential driveways and walkways that are steep.	20-30 Watts per square foot (215-323 Watts/M2)
Areas with average snow or light pedestrian traffic, residential driveways and walkways.	20+ Watts per square foot (215 Watts/M2)

* Pedestal Paver systems are designed at 37-40 watts per square foot due to system performance requirements.

STEP 4

CONFIRM RECEIVED MATERIALS

When materials arrive, examine the materials and the packaging for damage. If damage is present file a claim with the delivering company and copy Heatizon Systems. If no damage is present examine the Hott-Wire® snow melt system and compare the list of materials ordered to those received.

STEP 5

MEASURE & RECORD RESISTANCE (1)

Remove the Hott-Wire® Heating Element from the box. Insulation and Cable Resistance measurements MUST BE TAKEN three times during the installation process: 1. Immediately upon removal from the packaging; 2. After installation of the heating element; Following cement, asphalt, or paver application.

Check product label for proper resistance, operating amperage, operating voltage, cable length and other important information when performing tests. Compare label data to the results of the following tests:

REQUIRED TESTS



Cable Conductor Resistance with Multimeter

Before, during, and after installation, it is necessary to measure the resistance Ω of the heating circuit with a multimeter. The measured values should be equal -5% to +10% of label data.

- Connect one meter lead to one cold lead inner conductor and the other meter lead to the other cold lead inner conductor. Take the Ohm Ω reading. Record the measured values in the Resistance Recording Table at the back of this manual.

BE SURE TO NOT TOUCH THE WIRES WITH YOUR BARE HANDS WHILE DOING THIS TEST



(CONTINUED)



NOTES: The Megohmmeter or “Megger” is different from a multimeter and is a very specialized tool. Proper usage of a Megohmmeter is required or accurate test results and user safety.

Insulation Resistance with Megohmmeter

Before, during, and after installation, it is necessary to measure the insulation resistance between the heating conductor and the protective grounding braid or sheath with a 500VDC Megohmmeter. This measured value must be greater than 20 Megohms.

- Connect the voltage lead to the inner cold lead conductors and the earth lead to the cold lead outer grounding braid or sheath. Test resistance at 500VDC. Record the measured values in the Resistance Recording Table at the back of this manual.



NOTES: Should you have any questions regarding any of the tests, or testing results, please contact the distributor you purchased the system from, or Heatizon directly: 888.239.1232

STEP 6

PREPARE AREA

CONCRETE AND ASPHALT PREPARATION:

Ensure that the substrate has been properly compacted and drainage has been satisfactorily addressed. For substrate preparation and concrete recommendations please refer to the page “A FEW CONCRETE SUGGESTIONS” previously in this manual. Other site preparation recommendations include, cleaning up the site to eliminate objects that may damage the heating element prior to, during and after the installation.

Use the site sketch to transfer the following information to the site.

- Identify and mark the location of any and all joints if the heating cable will be installed into a new asphalt or a concrete slab. Do not forget to use jumpers for any and all joints.
- Determine the location of the starting points of the heating element and the exit points for the cold leads. Connections must be embedded in asphalt, concrete, or other cementitious material. Do not sleeve the connection in conduit.
- Determine the location of the activation device. If using an in-slab temperature or temperature/ moisture sensor, mark the location for the activation device and install a conduit sleeve for the lead wire to the in-slab sensor. An automated activator is the “eyes and ears” of the snow melt system. It is important that it be installed in a location that will allow it to effectively turn the snow melt system “on” when it is needed and “off” when it is not needed. Verify the proper location has been selected for the activation device. Manual activators require human action—as a result they should be placed in a location that is convenient and easily accessible.

For retrofit snowmelt projects only: Using a chalk line, mark the desired location where each run of cable will be installed, using the predetermined appropriate spacing for the heating cable. Once the heating element locations are satisfactorily marked, cover each chalk line with a clear spray lacquer to protect the chalk lines during saw cutting.

(CONTINUED)



PEDESTAL PAVER SYSTEMS:

Confirm there is a plan for layouts of pedestal pans, brackets, and Hott-Wire® cable(s). Install the pedestals by following the manufacturers instructions before installing pans or brackets.

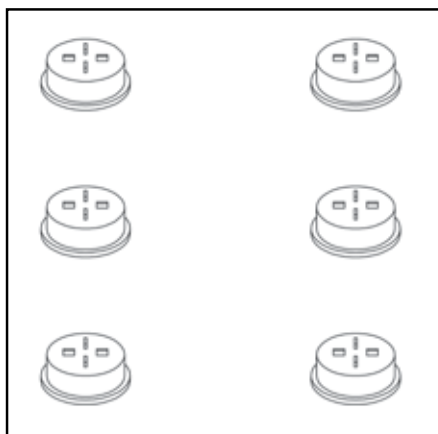

NOTES: One row of pavers may need to be installed at a time when laying the system out to allow access for work.

STEP 7

TRANSFER THE PLAN TO THE SITE

CONCRETE AND ASPHALT PREPARATION:

Ensure that the substrate has been properly compacted and flat, and that drainage has been satisfactorily addressed as required in the previous step for preparing the area.

Eliminate objects that may damage the Hott-Wire® Heating Element prior to installation. If Hott-Wire® is going to be installed into a new asphalt or concrete slab, identify and mark the location of any and all joints.

Using the site sketch, the spacing of Hott-Wire® Heating Element, and the calculated length of Hott-Wire® Heating Element, begin the installation. Note that the minimum spacing between the Hott-Wire® Heating Element runs cannot be less than 2 inches. Also note that the starting and ending points of the Hott-Wire® Single Conductor Heating Element ends must be near each other, but remain 2" apart.

Do not forget to use Heatizon part # MICABJMPKIT for any and all joints.



Hott-Wire® cables should be thoroughly tested before, during, and after installation to ensure they have not been damaged either in transit or during installation.

Determine the location of the connection points between the cold lead and the Hott-Wire® Heating Element. These connections must be embedded in asphalt, concrete, or other cementitious material when using Hott-Wire® Heating Element. Do not sleeve the connections in conduit.



Damage to the Hott-Wire® MI Heating Element is detectable with a 500VDC field megohmmeter. Cable insulation resistance should be measured on arrival of the cable. Cable with insulation resistance of less than 20 MΩ should not be used. Cable that shows a marked loss of insulation resistance after installation should be investigated for damage. Cable should also be checked for electrical continuity and proper resistance. Should you need assistance, call your distributor or Heatizon: 888.239.1232

(CONTINUED)



PEDESTAL PAVER SYSTEMS:

Heatizon Pedestal Paver Snow Melt systems are custom designed for each project. Please be sure to follow the layout design provided to you by an Authorized Heatizon Distributor or Representative when purchasing our Hott-Wire® MI Cable for your specific project.

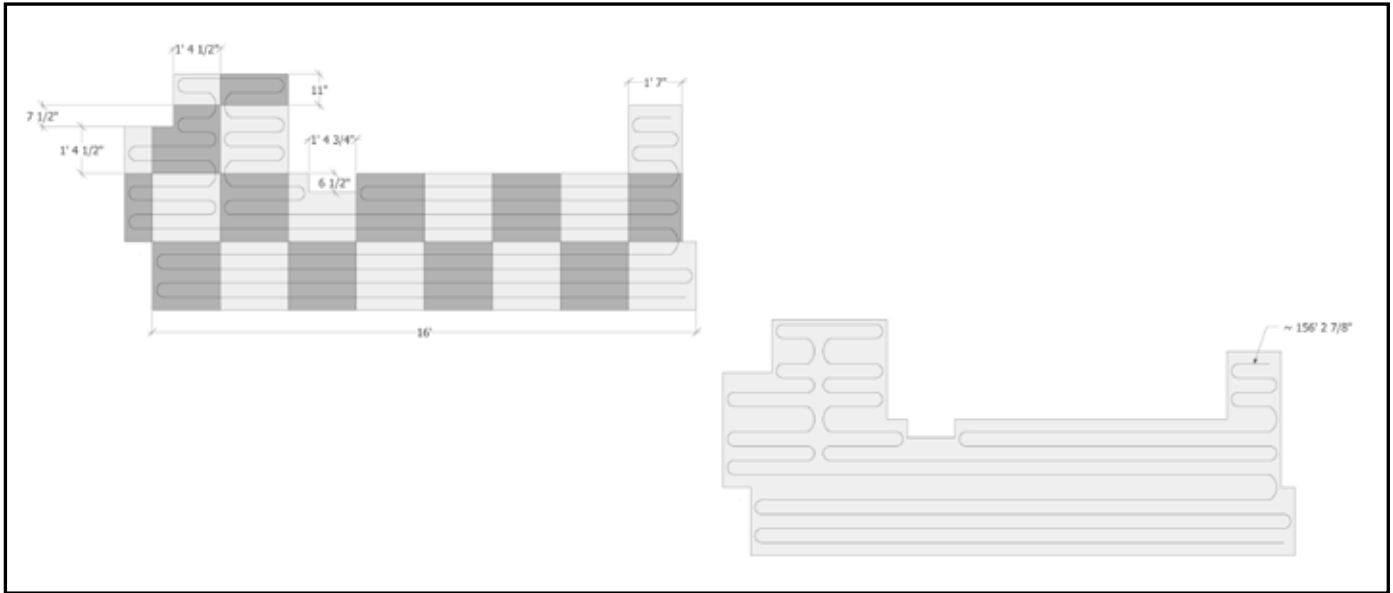

Brackets are placed across two pedestals to support the pan system. Brackets are installed perpendicular to the cable runs on the pan.

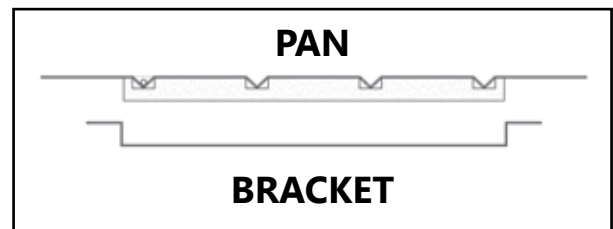
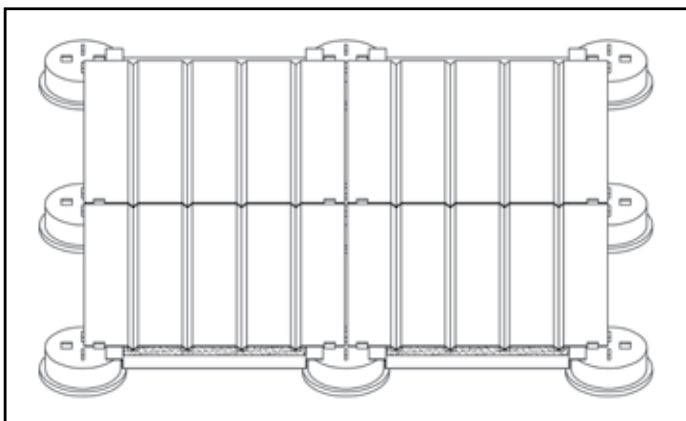
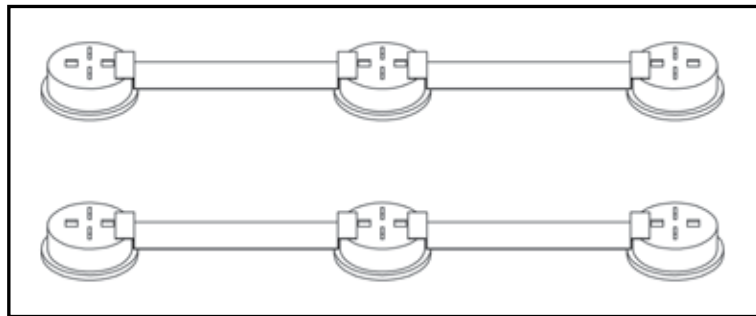

Once a row of brackets have been installed, the pan can be placed on top between the pedestals. Make sure to measure the spacing of the pedestals for the paver as the pan is slightly smaller than a paver to allow for expansion and contraction of the metal from heat.

NOTE: Some pans/brackets will be required to be modified (cut or trimmed) on site in order for the system to be correctly installed. Please consult project plans and cable layout to see which pans/brackets will need to be modified.



STEP 8

INSTALL Hott-Wire® HEATING ELEMENT

CONCRETE AND ASPHALT:

For loose cables, predetermined spacing is provided when ordering a system for desired watt density. Use the formula below to be sure all cable is used during installation and also to determine the watt density per square foot for performance. The required information for these formulas can be found on the Hott-Wire® product label and the site plan.

CALCULATE HEATING CABLE SPACING

_____	÷	_____	x 12 =	_____
Square Footage		Length of Heating Cable		Cable Spacing

CALCULATE WATT DENSITY PER SQUARE FOOT

12	÷	_____	x	_____	=	_____
		Cable Spacing (Above)		Watts Per Linear Foot		Watts per Square Foot

Make sure the connection points are in their desired locations before installing the heating cable zones. If working with a single conductor cable (2 cold leads) make certain that the Cold Lead can return back to the termination box or load switching panel.

Install the Hott-Wire® Heating Element so that the starting and ending connection points and any activation sensor(s) are in their desired locations. Make certain that both ends of the cold lead cable (if using single-conductor Hott-Wire® Cable) return back to the Hott-Wire® Termination Box or Heatizon Relay Panel.

Begin laying the Hott-Wire® Heating Element across the area to be snow-melted in evenly spaced runs per the system design and plan. Measure and record the resistance on the Resistance Recording Table at the back of this manual. Using a megohmmeter verify that the megohms are 20 or greater.

Hott-Wire® Heating Element may be secured in place by landscape stakes and plastic wire ties, welded wire fabric and plastic wire ties or tape, or pre-punched steel straps purchased from your Hott-Wire® Cable Distributor. Consult the NEC or CEC for grounding requirements.

Retrofitting Hott-Wire® Heating Element into existing concrete or asphalt surfaces requires cuts 3/8" thick and 1.5" deep.



Do not cut or shorten the Hott-Wire® Cable Heating Element. Do not damage or subject the Hott-Wire® Heating Element to mechanical or shear stress. Never cut or damage the insulator on Hott-Wire® Heating Element.

NOTE:

- Heatizon recommends that photographs of the installed Hott-Wire® Heating Element be taken and/or hand drawings documenting the layout be completed prior to pouring/installing the asphalt, concrete, or pavers.
- Always roll the spool to unreel the Hott-Wire® heating element. Do not pull Hott-Wire® from the spool.

(CONTINUED)



CONCRETE AND ASPHALT:

Concrete Overview: The heating cable may be secured in place by landscape stakes and plastic wire ties, welded wire fabric and plastic wire ties or tape, or pre-punched steel straps purchased from your Heatizon Distributor or Representative. Do not compress or strain the cable, run heavy machinery, equipment, or vehicles over it. Be careful to avoid stepping on the cold section factory connection of the cable. Consult the NEC or CEC for grounding requirements of rebar or welded wire fabric for concrete installations. When working with concrete or asphalt joints, design the layout so each section of the slab is covered and the cable crossing of joints are minimized. Cables should be installed in evenly spaced runs per the system design and plan. Sleeve hand rail posts to avoid drilling or penetrations in the slab after the pour.



- **Two Pour Concrete:** In this installation a concrete slab is already present and an additional slab will be poured on top. The heating cable can be laid out using welded wire fabric and zip ties or tape, or pre punched steel strapping for loose cable installations. Cold leads should be sleeved for this installation following conductor fill and size requirements in the NEC and CEC. The connection and heating cable portion can not pass into the conduit sleeve. Follow all requirements for installing nonheating leads for embedded equipment in the NEC and CEC. Jumpers must be used to protect the heating cable where joints are present on the concrete slab below as well as in the new slab.

- **Single Pour Concrete:** In this installation the aggregate or concrete base is prepared first. Once the base is prepared the installer can begin by placing a grid of welded wire fabric or rebar in preparation for the heating cable. The heating cables can be attached to the welded wire fabric with plastic zip ties or tape. Take note of layout examples on page 10 for installations requiring jumpers. Jumpers must be used for any and all joint cable crossings. Once the heating cable is installed, place chairs or concrete dobies under the rebar or welded wire fabric grid to bring the heating cable within 2" to 3" of the surface. Cold leads can be sleeved following conductor and fill size requirements in the NEC and CEC. Follow all requirements for installing nonheating leads for embedded equipment in the NEC and CEC. The connection and heating cable portion can not pass into any conduit sleeve.

Asphalt Overview: The heating cable may be secured in place by landscape stakes and plastic wire ties, welded wire fabric and plastic wire ties or tape, or pre-punched steel straps purchased from your Heatizon Distributor or Representative. Do not compress or strain the cable, run heavy machinery, equipment, or vehicles over it. Be careful to avoid stepping on the cold section factory connection of the cable. Consult the NEC or CEC for grounding requirements of rebar or welded wire fabric for asphalt installations. When working with concrete or asphalt joints, design the layout so each section of the slab is covered and the cable crossing of joints are minimized. Cables should be installed in evenly spaced runs per the system design and plan. Sleeve hand rail posts to avoid drilling or penetrations in the slab after the pour.

- **Two Pour Asphalt:** In this installation a binder or base coat of asphalt is laid down and an additional asphalt layer is placed on top of the heating cable. The base coat is to be rolled smooth in preparation of the heating cable installation. Welded wire mesh can be used to install loose cables in a grid. The grid can be secured to the base coat slab using stakes. Cold leads should be sleeved for this installation following conductor fill and size requirements in the NEC and CEC. Follow all requirements for installing nonheating leads for embedded equipment in the NEC and CEC. The connection and heating cable portion can not pass into the conduit sleeve. Jumpers must be used to protect the heating cable where any and all joints are present.



- **Single Pour Asphalt:** In this installation the aggregate or base is prepared first. Once the base is prepared, a layer of sand or stone dust is placed over the base coat approximately 1" thick. The installer can begin by placing a grid of welded wire fabric or landscaping stakes in preparation for the heating cable. The heating cables can be attached to the welded wire fabric, or landscaping stakes with plastic zip ties that will not melt. Jumpers must be used for any and all joint cable crossings. Cold leads should be sleeved following conductor and fill size requirements in the NEC and CEC. Follow all requirements for installing nonheating leads for embedded equipment in the NEC and CEC. The connection and heating cable portion can not pass into any conduit sleeve.

(CONTINUED)

PEDESTAL PAVER SYSTEMS:

Start the run of cable where specified on the pre designed layout for your project from an Authorized Heatizon Distributor. Follow the Hott-Wire® MI Cable instructions when installing the cable. Cables are laid in each groove and taped down with the provided heavy duty aluminum tape to hold the cables in place. Layouts will vary. NOTE: Cables make a bend outside of the pan system when running from run to run, across pans and also at the ends of the paver system at a wall. Cold lead connections start and end to transition in and out of the pan system to allow cold leads to run to the power source under the pan system. See drawing at the right for reference. Make sure to follow the NEC, CEC and local building codes when running conductors where conduit may be required as a sleeve.

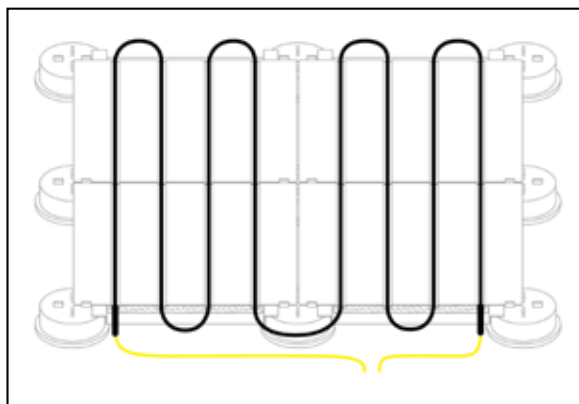

Where heating cable turns must be made against a wall or where a partial paver is used, the pan must be cut 5" shorter than the paver to allow for heating element turns to be made. Do not allow the heating element to touch the roofing materials if on a roof deck, they must be free and clear from all objects surrounding them. For cold connection transitions, all heating cable and the tapered portion of the connection must be within the pan assembly. Always use a bracket to support the pan when spanning across pedestals.

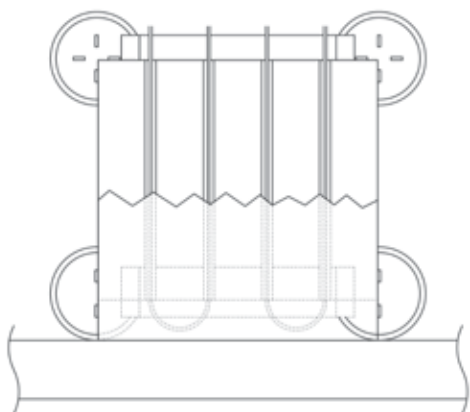

Do not cut or shorten the Hott-Wire® Cable Heating Element. Do not damage or subject the Hott-Wire® Heating Element to mechanical or shear stress from improper paver placement

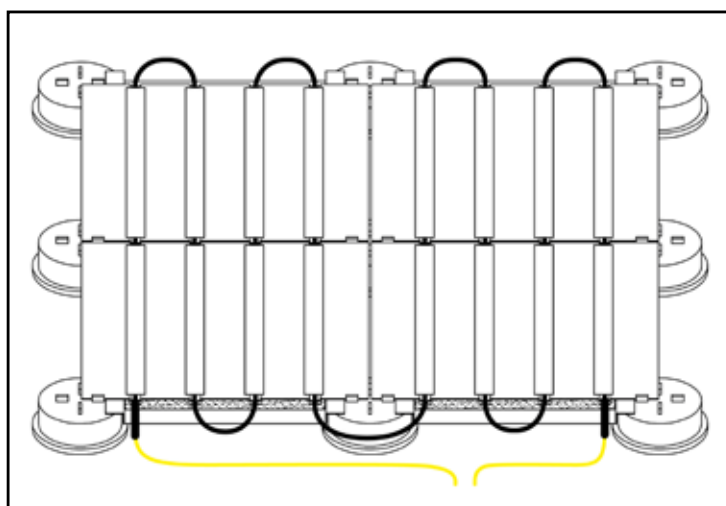

While laying the cable, small strips of tape can be used to temporarily hold the cable in place allowing for length adjustments at turns to accommodate the fixed length cable to be installed fully in the pans and transition cold connections out of the pan as previously referenced. Once the cable is completely laid out, the aluminum tape should fully cover the Hott-Wire® that is positioned in the pans to secure it for paver installation.

(CONTINUED)



HOTT-WIRE® INSTALLATION: RETROFIT, SAND, AND MORTAR

Retrofit Overview: Do not compress or strain the cable, run heavy machinery, equipment, or vehicles over it. Be careful to avoid stepping on the cold section factory connection of the cable. For retrofit installations, site preparation includes marking saw cuts with chalk lines and coating them with clear acrylic or laquer. Hott-Wire® MI Cable is a fixed length cable, therefore measuring for saw cuts must be precise.

- **Retrofit Installation:** Saw cuts measuring 3/8" wide and 1.5" deep are made into the asphalt or concrete. Touch up with a hand grinder may be needed to maintain consistent depths and widths at turns and along parallel runs. The cuts must be power washed and allowed to dry before the heating cable is installed. Follow local ordinances when performing saw cutting and cleanup. Insert the heating cable into the parallel cuts. Do not bend the heating cable closer than 3" to the cold joint. All cold lead factory connections must be embedded in saw cuts and covered. Cold leads can also be run in saw cuts back to exit points of the slab.



Sand Bed Paver Overview: The heating cable may be secured in place by landscape stakes and plastic wire ties, welded wire fabric and plastic wire ties or tape. Do not compress or strain the cable, run heavy machinery, equipment, or vehicles over it. Be careful to avoid stepping on the cold section factory connection of the cable.

- **Sand Bed Installation:** In this installation the aggregate or base is prepared first. Cover the base with 1/2" layer of compacted sand. Use welded wire fabric or landscape stakes to place heating cables on the layer of sand in accordance with determined layout. Cover the heating cable with another 1/2" layer of sand. The paver installer must be careful to not walk on the factory connection or damage the heating cable with shovels, rakes or tools. Cold leads should be sleeved for this installation following conductor fill and size requirements in the NEC and CEC. Follow all requirements for installing nonheating leads for embedded equipment in the NEC and CEC.

Mortar Under Stone & Tile Overview: The heating cable may be secured in place with pre-punched steel straps or anchor kits purchased from your Heatizon Distributor or Representative. Do not compress or strain the cable, run heavy machinery, equipment, or vehicles over it. Be careful to avoid stepping on the cold section factory connection of the cable.



- **Mortar Bed Installation:** Anchor the heating cable in parallel runs in preparation for mortar placement. Cold leads should also be anchored for this installation back to the exit point of the slab and placed in conduit following conductor fill and size requirements in the NEC and CEC.

STEP 9

ACTIVATOR LOCATION & INSTALLATION

An automated activator is the "eyes and ears" of the snow melt system. It is important that it be installed in a location that will allow it to turn the snow melt system "on" when it is needed and "off" when it is not needed.

Manual activators require user interaction, they should be placed in a location that is convenient and easily accessible.

Install the selected activator by carefully following the specific set of instructions that were included in the packaging.



Do not allow the sensor conduit to cross the Hott-Wire® Heating Element. Do not allow any part of the activator to touch the Hott-Wire® Heating Element.

NOTE:

If the selected activation device requires conduit for a temperature sensor, the conduit must be centered between two runs of Hott-Wire® Heating Element.

STEP 10

MEASURE & RECORD RESISTANCE (2)

Take your next insulation and cable resistance measurements now.

Required Tests

Cable Conductor Resistance with Multimeter

Before, during, and after installation, it is necessary to measure the resistance of the heating circuit with a multimeter. The measured values should be equal -5% to +10% of label data.

- Connect one meter lead to one cold lead inner conductor and the other meter lead to the other cold lead inner conductor. Take the Ohm Ω reading. Record the measured values in the Resistance Recording Table at the back of this manual.

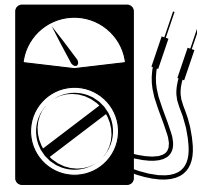

Insulation Resistance with Megohmmeter

Before, during, and after installation, it is necessary to measure the insulation resistance between the heating conductor and the protective grounding screen with a 500VDC Megohmmeter. This measured value must be greater than 20 Megohms.

- Connect the voltage lead to the inner cold lead conductors and the earth lead to the cold lead outer grounding braid or sheath. Test resistance at 500VDC. Record the measured values in the Resistance Recording Table at the back of this manual.



Do not cut or shorten the Hott-Wire® Cable Heating Element. Do not damage or subject the Hott-Wire® Heating Element to mechanical or shear stress. Never cut or damage the insulator on Hott-Wire® Heating Element.

STEP 11

APPLY THE ASPHALT, CONCRETE OR PAVERS

Ensure that any necessary sensor conduit has been properly installed before proceeding beyond this point. Heatizon recommends that photographs of the installed Hott-Wire® Heating Element be taken and/or hand drawings documenting the layout be completed prior to pouring/installing the asphalt, concrete, or pavers.

For Concrete Applications: Proceed with applying concrete. Make sure that the concrete covers the entire heating cable element and the connection between the heating cable and cold leads. Great care should be taken to not damage the heating cables by impacting, cutting or other abuse.

For Asphalt Applications: Heatizon Systems heating cable is of high quality and durable construction. As a result, it can tolerate the heat and compression of newly poured asphalt with some modification. The heating cable outer jacket can tolerate the temperatures of asphalt. For single pour asphalt, cover the heating element with 1/2" of substrate material prior to installing asphalt per the directions below. For both single and two pour asphalt installations place a layer of asphalt at least 1/2 inch thick over the cables by hand, and roll with a roller of approximately 1.5 ton size. This will protect the heating cables from damage by tools or paving equipment and will protect the cable during placement of the main pour. Continuously check the insulation resistance of the heating cables to verify that the cables are not damaged during placement of the asphalt. Continue with the main pour.

For Retrofit Applications in Concrete or Asphalt: Place 1/2" backer rod over the cable at about 1/4" depth from the surface. Placing the backer rod at this depth minimizes sealant usage and improves sealant strength. Use the approved Heatizon sealants to seal concrete saw cuts and asphalt saw cuts with regard to slope.

(CONTINUED)



For Paver Applications: Proceed with the installation by covering the heating cable with a layer of sand or stone dust. Ensure that the sand or stone dust covers the entire heating element and the connection between the heating element and cold leads before the pavers are installed. Great care should be taken to not damage the heating cables by impacting, cutting or other abuse.

For Stone or Tile with Mortar Applications: Cover the heating cable with mortar to completely embed the cable and allow it to set. Allowing the first layer of mortar to set will protect the heating cables during the final installation and the setting bed for stone or tile. Install the Stone or Tile and

keep note that the final cable depth of the cable from the surface should be 1.5". Great care should be taken to not damage the heating cables by impacting, cutting or other abuse.

For Pedestal Paver Applications: After the cable has been fully taped and secured to the pans, the pavers can be installed on top of the system. Care should be taken to ensure that the cable is not damaged or kinked when installing the pavers.

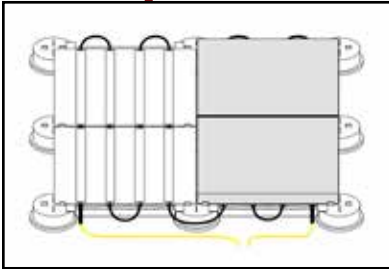

Eliminate all moisture in the concrete, asphalt or sand/stone dust bed in accordance with drying times recommended by the manufacturer or supplier. The system must not be turned on until concrete or asphalt product has fully cured (a minimum of 7 days is recommended). Once the asphalt or concrete has cured, measure and record resistance on Resistance Recording Table at the back of this manual and verify greater than 20 megohms using a megohmmeter.

STEP 12

MEASURE & RECORD RESISTANCE (3)

Once the asphalt or concrete has cured, take your next Insulation and Cable Resistance measurements. Eliminate all moisture in the concrete, asphalt or sand/stone dust bed in accordance with drying times recommended by the manufacturer or supplier. The system must not be turned on until concrete or asphalt product has fully cured (a minimum of 7 days is recommended). Pedestal Pavers systems can be tested at soon as the final paver covering the Hott-Wire® system has been placed.

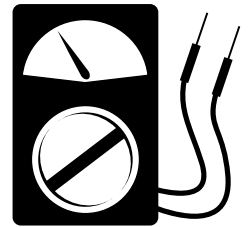

Required Tests

Cable Conductor Resistance with Multimeter

Before, during, and after installation, it is necessary to measure the resistance of the heating circuit with a multimeter. The measured values should be equal -5% to +10% of label data.

- Connect one meter lead to one cold lead inner conductor and the other meter lead to the other cold lead inner conductor. Take the Ohm Ω reading. Record the measured values in the Resistance Recording Table at the back of this manual.

Insulation Resistance with Megohmmeter

Before, during, and after installation, it is necessary to measure the insulation resistance between the heating conductor and the protective grounding screen with a 500VDC Megohmmeter. This measured value must be greater than 20 Megohms.

- Connect the voltage lead to the inner cold lead conductors and the earth lead to the cold lead outer grounding braid or sheath. Test resistance at 500VDC. Record the measured values in the Resistance Recording Table at the back of this manual.



STEP 13

CONNECT POWER SUPPLY & ACTIVATION

The connection of the power supply and the activation device must be done by a qualified electrician in accordance with the National Electrical Code (NEC) and the Canadian Electrical Code (CEC).

Electrical Requirements:

- 120 or 277 VAC — Single Phase
- 208, 240, or 480 VAC — Two Phase

NOTE:

- The breaker amperage rating is determined by specific product selected.
- Hott-Wire® voltage to be used, is denoted on the cable's label.
- Instructions for Activation devices will accompany the device.
- If the project uses a Heatizon Relay or Contactor panel, instructions and wiring will be included with the panel. Please consult those instructions prior to making power connections.

The shield from the Cold Lead(s) must be wired to Ground for all primary power installations. Measure a final resistance reading at this stage in the installation and record on Resistance Recording Table at the back of this manual.

STEP 14

TROUBLESHOOTING

Problem: Hott-Wire® Cable fails the Megohmmeter Test Potential Causes:

- Inspect the Hott-Wire® Cable for damage to the insulator or copper shield, and/or contact between the copper shield and the core wire(s). Repair using #MISPLICEKIT or replace entire length of damaged Hott-Wire® Cable.
- Call Heatizon Systems technical support at: 801-293-1232

NOTE:

In the event the Hott-Wire® Cable has not been damaged in any way, remove and replace the entire length of Hott-Wire® Cable. For Warranty claims, please return the entire length of Hott-Wire® Cable to Heatizon Systems, with the end termination and power termination connections intact, for evaluation prior to replacement.

STEP 15

COMPLETE AND ATTACH LABELS

Place the included labels in the following locations:

- Electrical Panel Label - Inside door at electrical service panel. This label matches the label that is attached to the non-heating Cold Lead at the factory.
- Stop Sign Warning Label - on or near the area which is heated by Hott-Wire® Cable.
- Optional Pavement Warning Marker - on or near the area which is heated by Hott-Wire® Cable.



NOTE:

Make certain to record information from the Product Identification Label, which can be found on the Cold Lead portion of each heating cable.

**ENJOY YOUR NEW Hott-Wire®
SNOW MELTING SYSTEM!**



**Be sure to fill out and return the warranty/
reading form at the back of this manual to
ensure full warranty protection.**

Hott-Wire® Cable Warranty

Heatizon Systems warrants Hott-Wire® Heating Element to be free from defects in material and workmanship for a period of ten (10) years and Activation Device(s) and Panels for a period of one (1) year. Such warranty periods shall commence on the date of shipment by Heatizon Systems. If any parts are found to be defective in manufacture during such time period, Heatizon Systems will, at its sole option, replace or repair defective parts.

This Limited Warranty applies only if articles sold hereunder (a) are selected, designed, and installed according to instruction and operation manuals furnished by Heatizon Systems and installed in a "workmanlike manner" according to the building association standards adopted by Heatizon Systems, (b) remain in their originally installed location, (c) are connected to proper power supplies, (d) are not misused or abused, (e) show no evidence of tampering, mishandling, neglect, damage (accidental or otherwise), modifications or repair without the approval of Heatizon Systems, or damage done to the product by anyone other than Heatizon Systems, and (f) are installed in accordance with applicable code requirements. Any warranty claims must be made in writing, no later than one (1) month following expiration of the warranty period, and must be accompanied by the warranted part or component. Any claim not made in such manner shall not be honored by Heatizon Systems.

This Limited Warranty does not cover:

1. The workmanship of any installer of Heatizon Systems radiant panel or cable heating products.
2. Any Heatizon Systems radiant heating products that have a failure or malfunction resulting from improper or negligent operation, installation, accident, abuse, misuse, unauthorized alteration, improper repair or maintenance, or acts of God.
3. Any Heatizon Systems radiant heating products that have had components not purchased from Heatizon Systems integrated into or connected to them.
4. Any labor costs for removal of alleged defective part(s) and/or reinstallation of replacement part(s), transportation to and from Heatizon Systems (if necessary) and any other material necessary to perform the exchange or repair.
5. Any Heatizon Systems heating products that have not been properly registered by completion and return of the Warranty Registration Card attached hereto within ninety (90) days of the date of sale.

DISCLAIMER OF WARRANTIES:

This warranty described above is in lieu of all other warranties, express or implied, including but not limited to any implied warranties of fitness for a particular purpose and merchantability. Heatizon Systems expressly disclaims and excludes any liability for losses, expenses, inconveniences, consequential, incidental, indirect, or punitive damages for breach of any express or implied warranty. By installing and/or purchasing Heatizon Systems products, you accept the terms of this limited warranty.

Some states do not allow the exclusion or limitation of incidental or consequential damages, or limitations on how long an implied warranty lasts, so the above limitations and exclusions may not apply to you. This Limited Warranty gives you specific legal rights, and you may also have other rights which may vary from state to state.



HOW TO MAKE A WARRANTY CLAIM

1. Gather the following information:
 - Date of purchase
 - Who product was purchased from
 - Date of installation, if installed
 - Names and phone numbers of electrician/installer
 - Completed resistance recording page from installation
 - Serial number (if applicable) from product label
2. Contact Heatizon Systems for a Return Materials Authorization number, and information on the next required steps to complete your warranty claim.



HEATIZON
S Y S T E M S

Heatizon Systems

4137 South 500 West
Murray, UT 84123
Phone (801) 293-1232
Fax (801) 293-3077
heatizon.com

RESISTANCE RECORDING/WARRANTY PAGE



Mail in the warranty certificate immediately after installing the Hott-Wire® Cable system. Failure to complete the warranty card could void the manufacturer's warranty. The warranty is subject to the guarantee conditions listed on the warranty certificate, and upon documentation that the required resistance tests were completed. You may wish to keep a copy of the warranty card for your reference.

Use a Digital Multi Meter to measure the resistance Ω of the Hott-Wire® Heating Element, and verify the reading with the expected resistance Ω for the product purchased, available on the product label. Hott-Wire® Cable are to be tested using a megohmmeter, set at 500 VDC. The measured value should not be less than 20 Megohms. Verify the resistance of the MI Cable using an ohmmeter. Expected Ohms/ft are shown on the label information. Record all test results below.



Expected Ohms/ft are shown on the label information. Record all test results below.

PRODUCT & ACCESSORY INFORMATION
Heatizon M330 Relay Panel *
Heatizon M530 Contactor Panel*
Heatizon M329 Selector Box or M346 Monitor Station
Heatizon Pavement Sensor
Heatizon Aerial Sensor
* Panel Upgrade options available for load sharing and activation

CUSTOMER WARRANTY INFORMATION

Name			
Address			
City		State	Zip
Phone		Email	

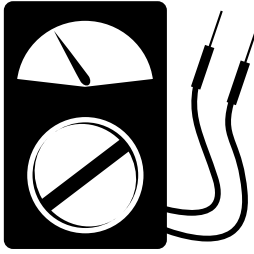

Prior to Installation (1) (When removed from Package)	After Installation of Hott-Wire® MI Heating Element on Substraight (2)	After Asphalt or Paved Concrete Application (3)
_____ Ω _____ M Ω	_____ Ω _____ M Ω	_____ Ω _____ M Ω
DATE _____ TIME _____	DATE _____ TIME _____	DATE _____ TIME _____

PURCHASED PRODUCT DETAILS

Model		Size		SQ. FT.
Manufacture Date		Serial Number		
Watts & Volts	Watts	Volts	Ohms	Ω
Surface	<input type="checkbox"/> Concrete	<input type="checkbox"/> Asphalt	<input type="checkbox"/> Sand Bed	<input type="checkbox"/> Retrofit
			<input type="checkbox"/> Pedestal Pans	<input type="checkbox"/> Other

Heatizon Systems

4137 South 500 West

Murray, UT 84123

Phone: (801) 293-1232

Fax: (801) 293-3077

info@heatizon.com

heatizon.com

Pedestal Paver Layout Example

